

Performance curves

LBS 80-200

Single-stage bare shaft end-suction pumps

6-pole

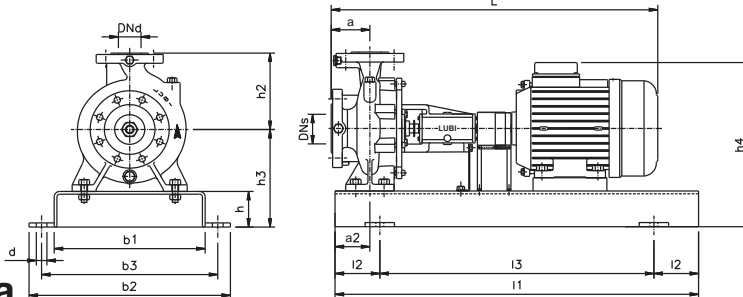
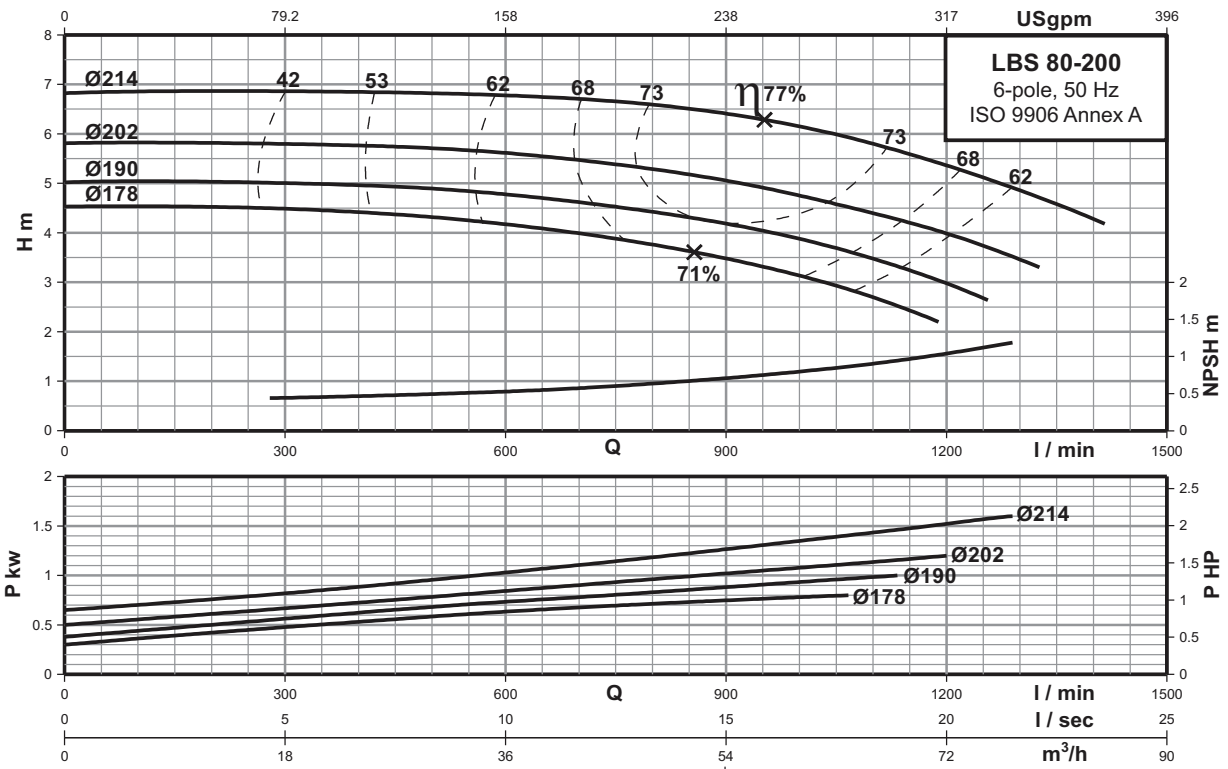

Technical data

Power	[kw]	0.75	1.1	1.5
	[hp]	1	1.5	2
Frame		90S	90L	100L
PN	[bar]	16	16	16
DNs	[mm]	100	100	100
DNd	[mm]	80	80	80
a	[mm]	125	125	125
h2	[mm]	250	250	250
L	[mm]	925	939	981
l1	[mm]	1120	1120	1120
l2	[mm]	190	190	190
l3	[mm]	740	740	740
b1	[mm]	380	380	380
b2	[mm]	490	490	490
b3	[mm]	440	440	440
d	[mm]	24	24	24
a2	[mm]	75	75	75
h	[mm]	80	80	80
h3	[mm]	260	260	260
h4	[mm]	349	386	412
Base frame no.		5	5	5
Net Weight	[kg]	112	114	133
Gross Weight	[kg]	191	193	212
Volume	[m ³]	0.660	0.660	0.660

6 POLE

Performance curves

LBS 80-250

Single-stage bare shaft end-suction pumps

6-pole

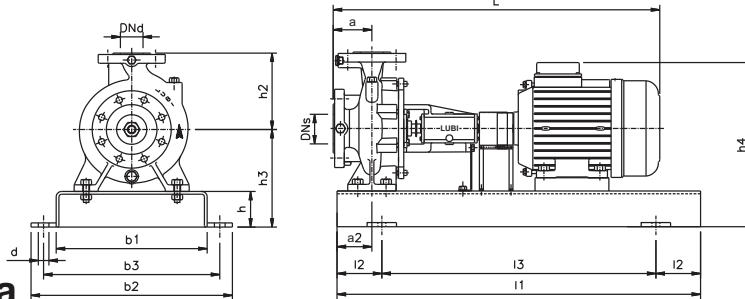
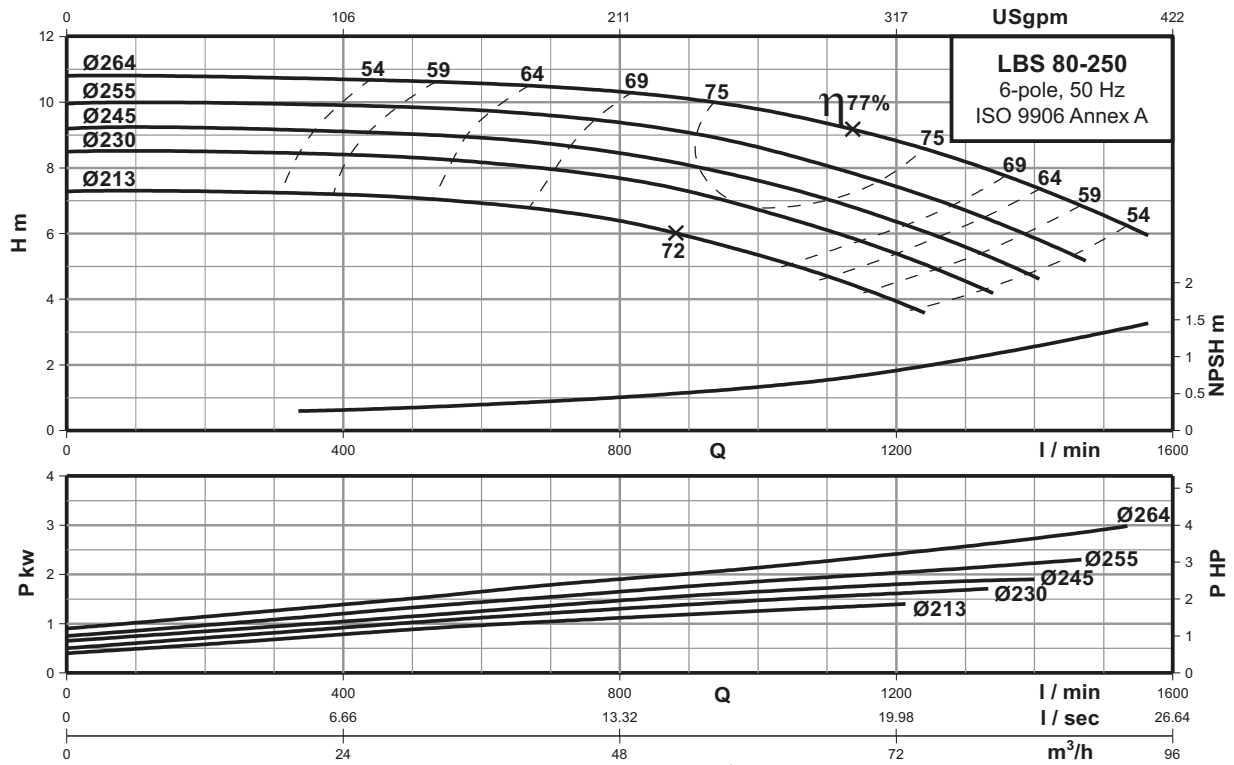

Technical data

Power	[kw]	1.5	2.2	3
	[hp]	2	3	4
Frame		100L	112M	132S
PN	[bar]	16	16	16
DNs	[mm]	100	100	100
DNd	[mm]	80	80	80
a	[mm]	125	125	125
h2	[mm]	280	280	280
L	[mm]	981	1011	1076
l1	[mm]	1250	1250	1250
l2	[mm]	205	205	205
l3	[mm]	840	840	840
b1	[mm]	430	430	430
b2	[mm]	540	540	540
b3	[mm]	490	490	490
d	[mm]	24	24	24
a2	[mm]	90	90	90
h	[mm]	80	80	80
h3	[mm]	280	280	280
h4	[mm]	432	444	484
Base frame no.		6	6	6
Net Weight	[kg]	153	159	186
Gross Weight	[kg]	244	250	277
Volume	[m³]	0.821	0.821	0.821

6 POLE

Performance curves

LBS 65-250L

Single-stage bare shaft end-suction pumps

6-pole

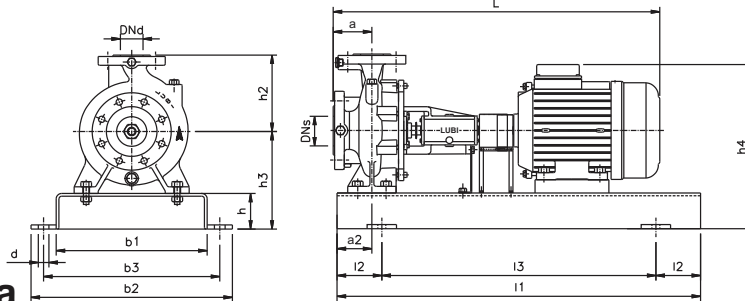
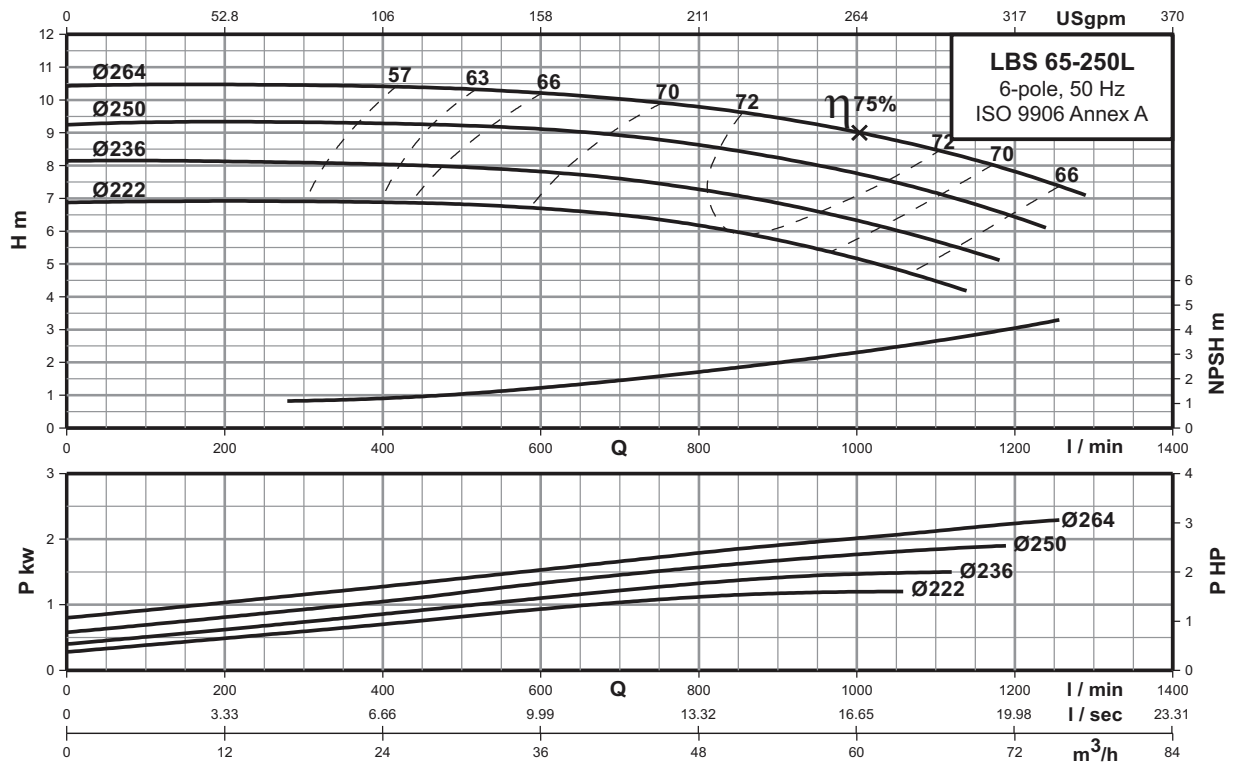

Technical data

Power	[kw]	1.1	1.5	2.2
	[hp]	1.5	2	3
Frame		90L	100L	112M
PN	[bar]	16	16	16
DNs	[mm]	100	100	100
DNd	[mm]	65	65	65
a	[mm]	100	100	100
h2	[mm]	250	250	250
L	[mm]	915	956	986
i1	[mm]	1120	1120	1120
i2	[mm]	190	190	190
i3	[mm]	740	740	740
b1	[mm]	380	380	380
b2	[mm]	490	490	490
b3	[mm]	440	440	440
d	[mm]	24	24	24
a2	[mm]	90	90	90
h	[mm]	80	80	80
h3	[mm]	280	280	280
h4	[mm]	406	432	444
Base frame no.		5	5	5
Net Weight	[kg]	122	141	146
Gross Weight	[kg]	201	220	225
Volume	[m³]	0.660	0.660	0.660

6 POLE

Performance curves

LBS 80-315

Single-stage bare shaft end-suction pumps

6-pole

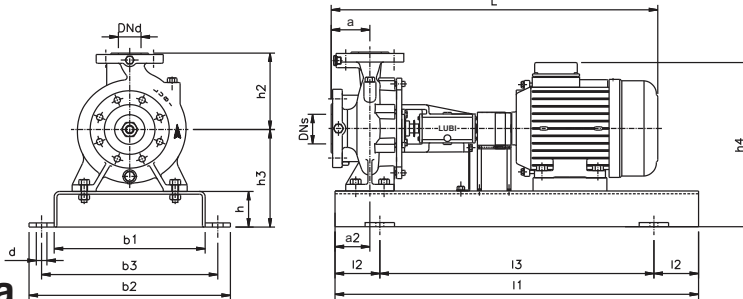
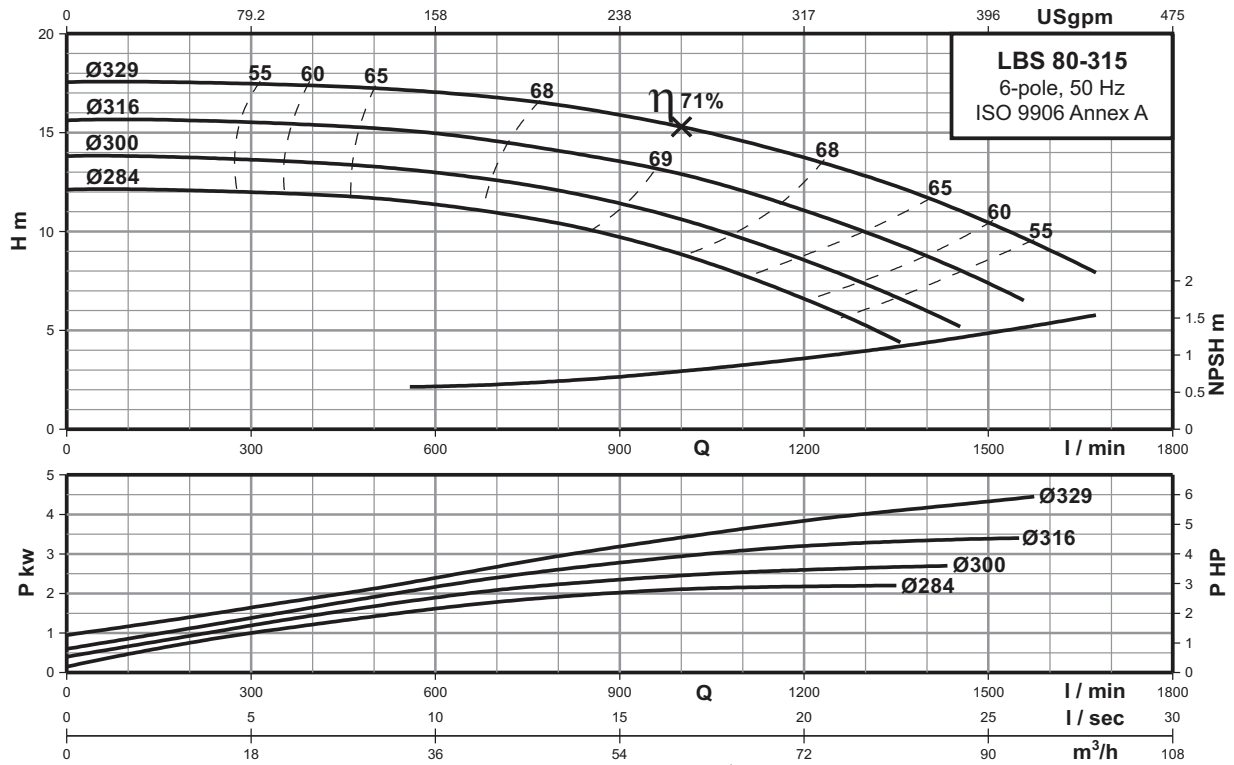

Technical data

Power	[kw]	2.2	3	4
	[hp]	3	4	5.5
Frame		112M	132S	132S
PN	[bar]	16	16	16
DNs	[mm]	100	100	100
DNd	[mm]	80	80	80
a	[mm]	125	125	125
h2	[mm]	315	315	315
L	[mm]	1011	1076	1076
i1	[mm]	1250	1250	1250
i2	[mm]	205	205	205
i3	[mm]	840	840	840
b1	[mm]	430	430	430
b2	[mm]	540	540	540
b3	[mm]	490	490	490
d	[mm]	24	24	24
a2	[mm]	90	90	90
h	[mm]	80	80	80
h3	[mm]	330	330	330
h4	[mm]	494	534	534
Base frame no.		6	6	6
Net Weight	[kg]	172	199	201
Gross Weight	[kg]	268	295	297
Volume	[m ³]	0.898	0.898	0.898

6 POLE

Performance curves

LBS 80-400

Single-stage bare shaft end-suction pumps

6-pole

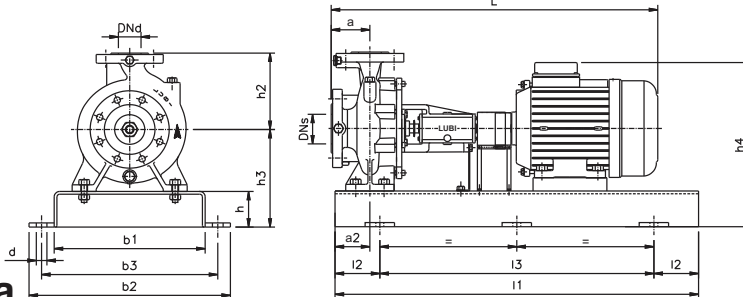
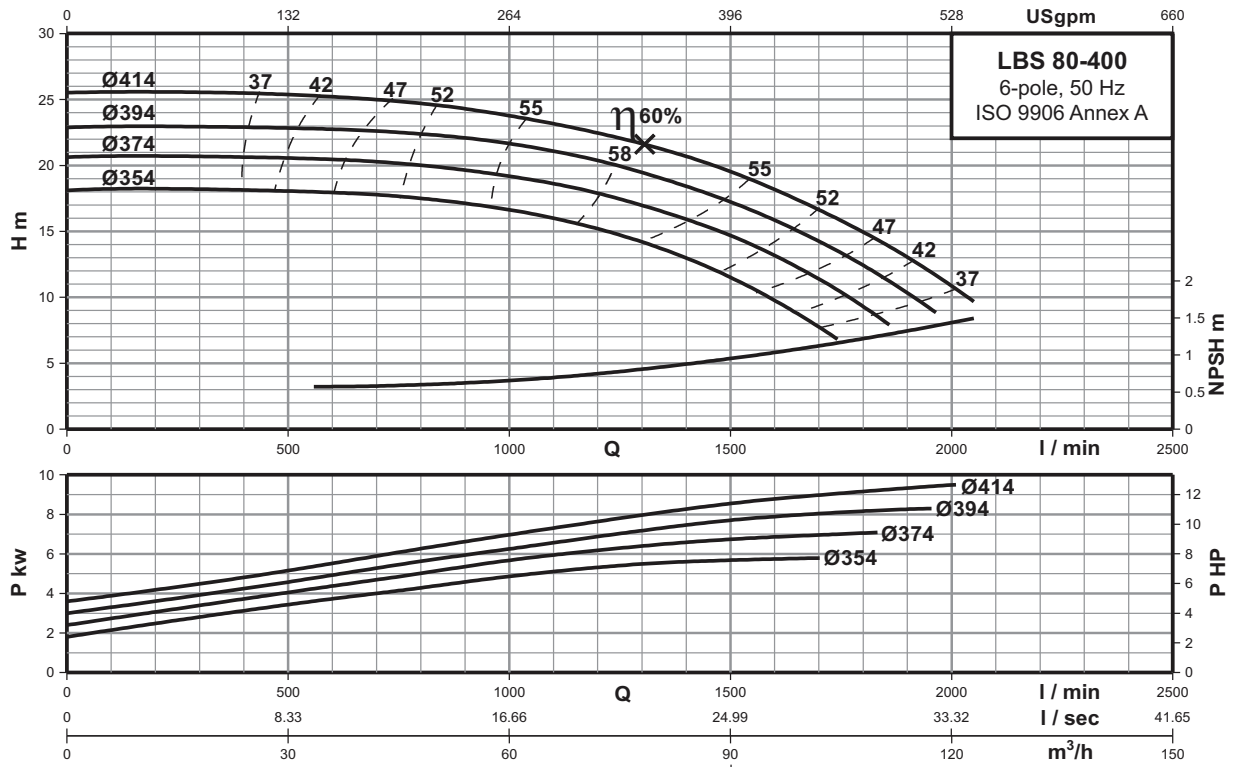

Technical data

Power	[kw]	5.5	7.5	9.3
	[hp]	7.5	10	12.5
Frame		132M	160M	160M
PN	[bar]	16	16	16
DNs	[mm]	100	100	100
DNd	[mm]	80	80	80
a	[mm]	140	140	140
h2	[mm]	355	355	355
L	[mm]	1189	1289	1289
l1	[mm]	1600	1600	1600
l2	[mm]	270	270	270
l3	[mm]	1060	1060	1060
b1	[mm]	530	530	530
b2	[mm]	660	660	660
b3	[mm]	600	600	600
d	[mm]	28	28	28
a2	[mm]	110	110	110
h	[mm]	100	100	100
h3	[mm]	380	380	380
h4	[mm]	584	623	623
Base frame no.		8	8	8
Net Weight	[kg]	307	331	337
Gross Weight	[kg]	438	462	468
Volume	[m³]	1.452	1.452	1.452

6 POLE

Performance curves

LBS 100-200

Single-stage bare shaft end-suction pumps

6-pole

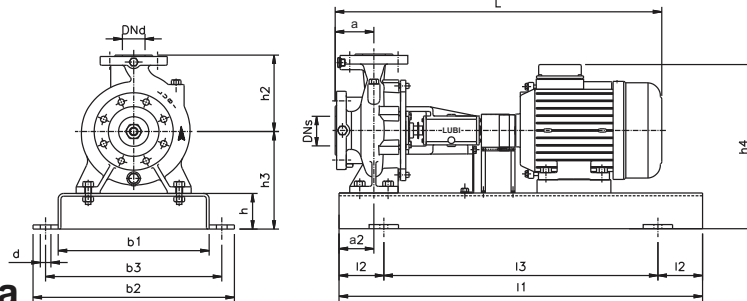
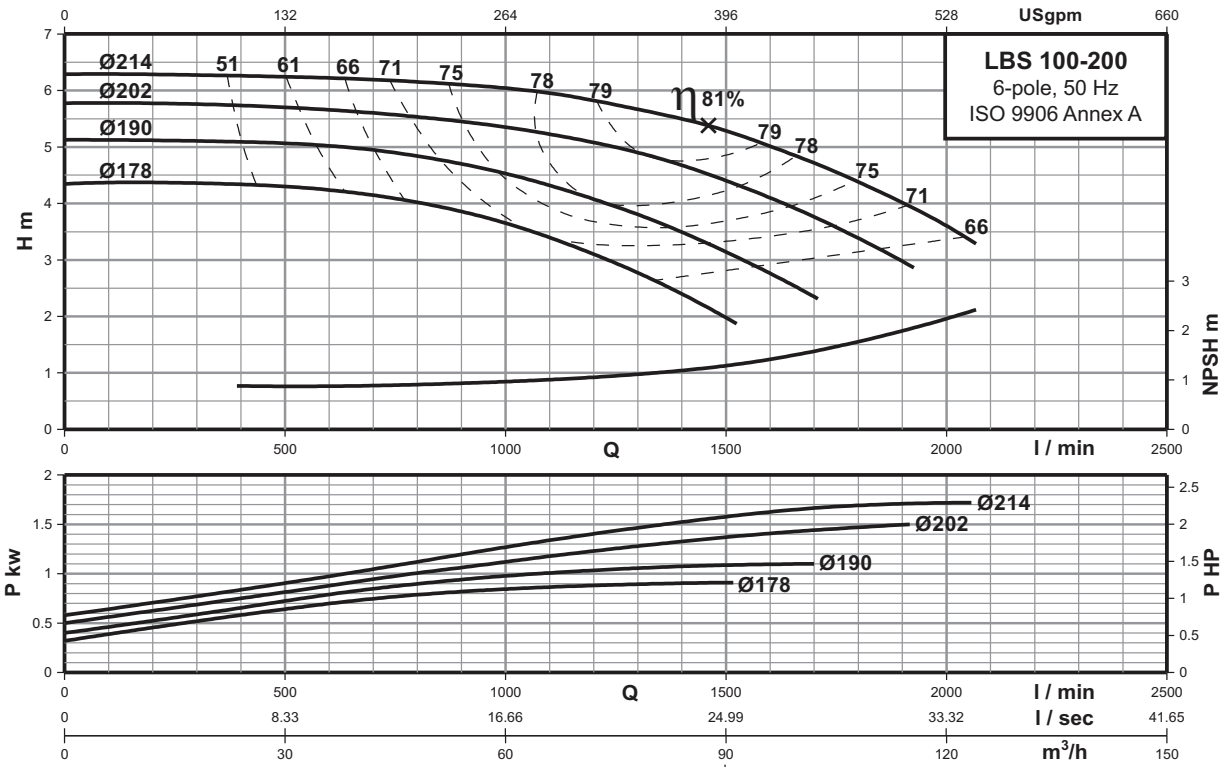

Technical data

Power	[kw]	0.75	1.1	1.5	2.2
	[hp]	1	1.5	2	3
Frame		90S	90L	100L	112M
PN	[bar]	16	16	16	16
DNs	[mm]	125	125	125	125
DNd	[mm]	100	100	100	100
a	[mm]	125	125	125	140
h2	[mm]	280	280	280	280
L	[mm]	925	939	981	1011
i1	[mm]	1120	1120	1120	1120
i2	[mm]	190	190	190	190
i3	[mm]	740	740	740	740
b1	[mm]	380	380	380	380
b2	[mm]	490	490	490	490
b3	[mm]	440	440	440	440
d	[mm]	24	24	24	24
a2	[mm]	90	90	90	90
h	[mm]	80	80	80	80
h3	[mm]	280	280	280	280
h4	[mm]	369	406	432	444
Base frame no.		5	5	5	5
Net Weight	[kg]	123	125	144	149
Gross Weight	[kg]	202	204	223	228
Volume	[m³]	0.660	0.660	0.660	0.660

6 POLE

Performance curves

LBS 100-250

Single-stage bare shaft end-suction pumps

6-pole

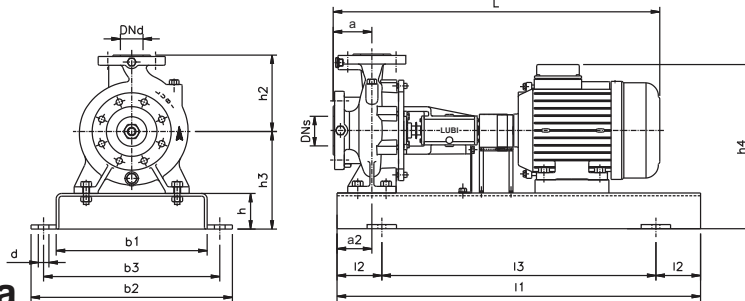
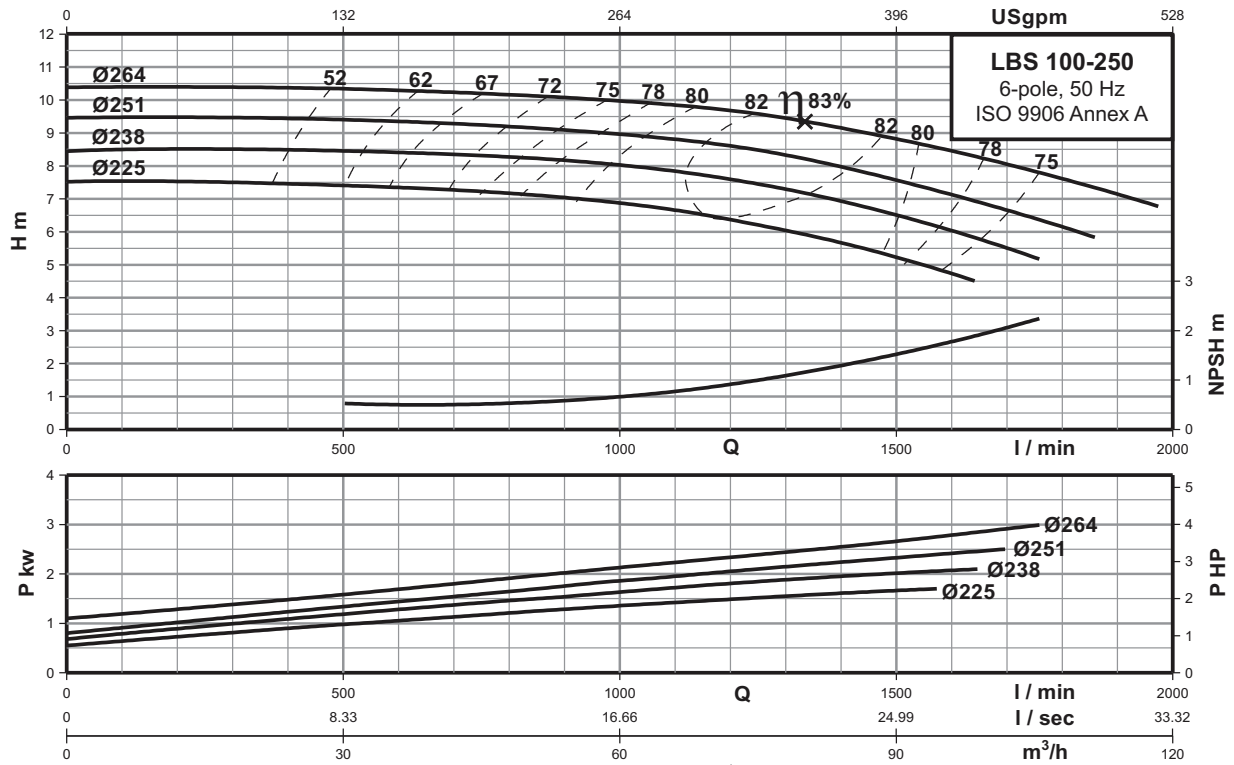

Technical data

Power	[kw]	1.5	2.2	3
	[hp]	2	3	4
Frame		100L	112M	132S
PN	[bar]	16	16	16
DNs	[mm]	125	125	125
DNd	[mm]	100	100	100
a	[mm]	140	140	140
h2	[mm]	280	280	280
L	[mm]	996	1026	1091
i1	[mm]	1250	1250	1250
i2	[mm]	205	205	205
i3	[mm]	840	840	840
b1	[mm]	430	430	430
b2	[mm]	540	540	540
b3	[mm]	490	490	490
d	[mm]	24	24	24
a2	[mm]	90	90	90
h	[mm]	80	80	80
h3	[mm]	305	305	305
h4	[mm]	457	469	509
Base frame no.		6	6	6
Net Weight	[kg]	161	167	194
Gross Weight	[kg]	252	258	285
Volume	[m ³]	0.821	0.821	0.821

6 POLE

Performance curves

LBS 100-315

Single-stage bare shaft end-suction pumps

6-pole

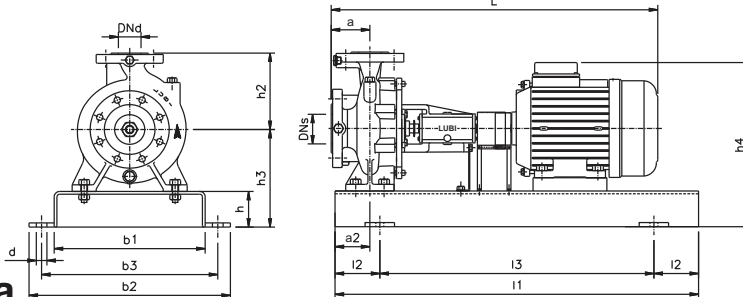
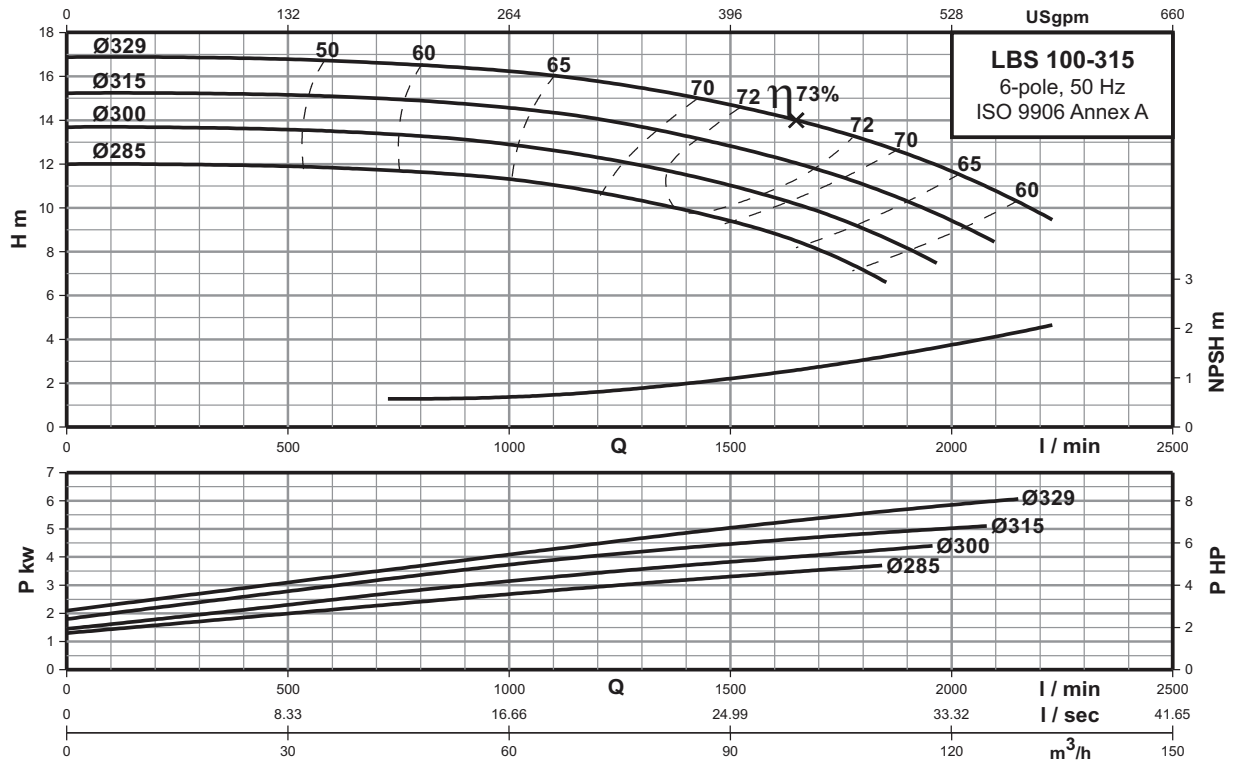

Technical data

Power	[kw]	4	5.5	7.5
	[hp]	5.5	7.5	10
Frame		132S	132M	160M
PN	[bar]	16	16	16
DNs	[mm]	125	125	125
DNd	[mm]	100	100	100
a	[mm]	140	140	140
h2	[mm]	315	315	315
L	[mm]	1091	1129	1232
l1	[mm]	1250	1250	1250
l2	[mm]	205	205	205
l3	[mm]	840	840	840
b1	[mm]	430	430	430
b2	[mm]	540	540	540
b3	[mm]	490	490	490
d	[mm]	24	24	24
a2	[mm]	90	90	90
h	[mm]	80	80	80
h3	[mm]	330	330	330
h4	[mm]	534	534	573
Base frame no.		6	6	6
Net Weight	[kg]	210	229	253
Gross Weight	[kg]	306	325	349
Volume	[m³]	0.898	0.898	0.898

6 POLE

Performance curves

LBS 100-400

Single-stage bare shaft end-suction pumps

6-pole

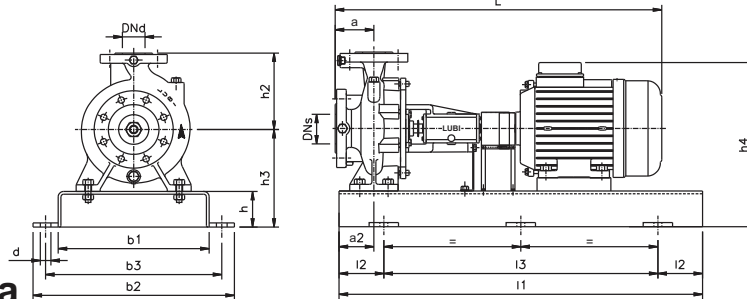
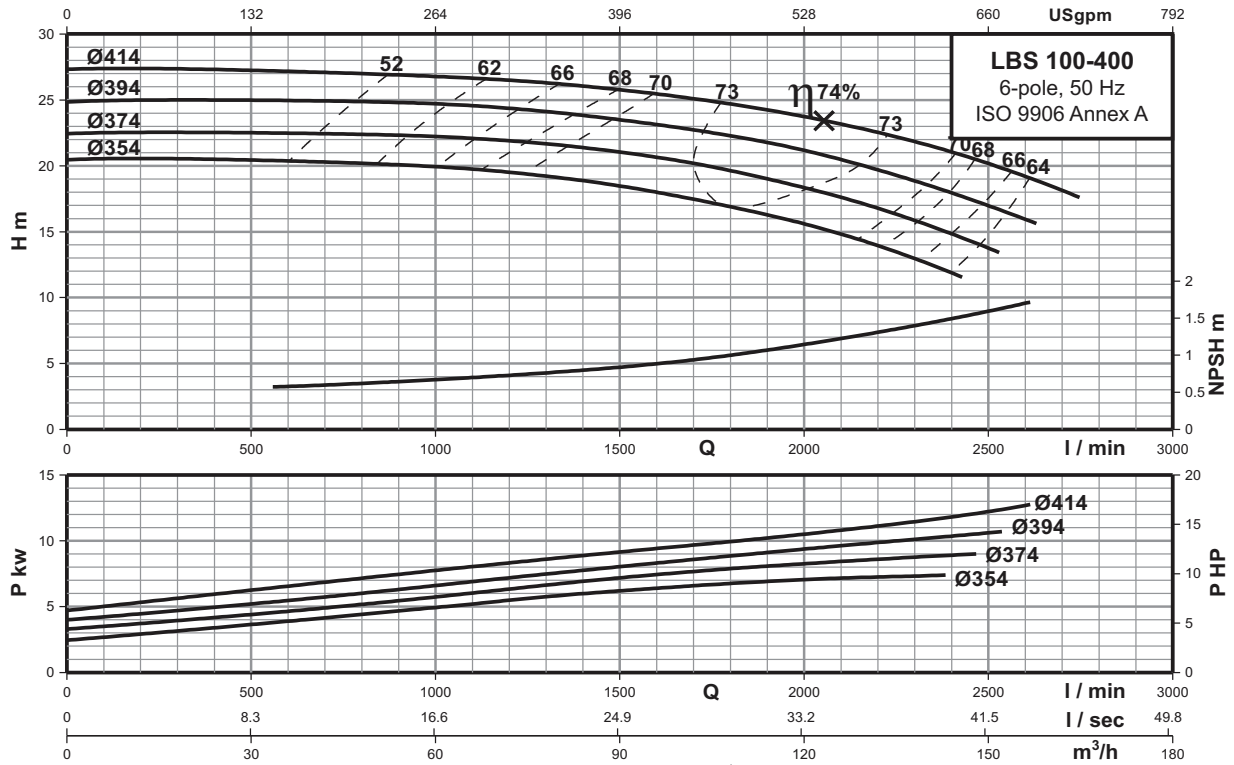

Technical data

Power	[kw]	7.5	9.3	11	15
	[hp]	10	12.5	15	20
Frame		160M	160M	160L	180L
PN	[bar]	16	16	16	16
DNs	[mm]	125	125	125	125
DNd	[mm]	100	100	100	100
a	[mm]	140	140	140	140
h2	[mm]	355	355	355	355
L	[mm]	1289	1289	1334	1426
i1	[mm]	1600	1600	1600	1600
i2	[mm]	270	270	270	270
i3	[mm]	1060	1060	1060	1060
b1	[mm]	530	530	530	530
b2	[mm]	660	660	660	660
b3	[mm]	600	600	600	600
d	[mm]	28	28	28	28
a2	[mm]	110	110	110	110
h	[mm]	100	100	100	100
h3	[mm]	380	380	380	380
h4	[mm]	623	623	623	674
Base frame no.		8	8	8	8
Net Weight	[kg]	331	337	351	440
Gross Weight	[kg]	462	468	482	571
Volume	[m³]	1.452	1.452	1.452	1.452

6 POLE

Performance curves

LBS 125-250

Single-stage bare shaft end-suction pumps

6-pole

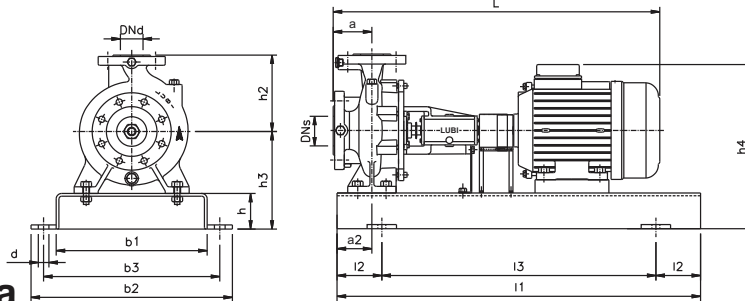
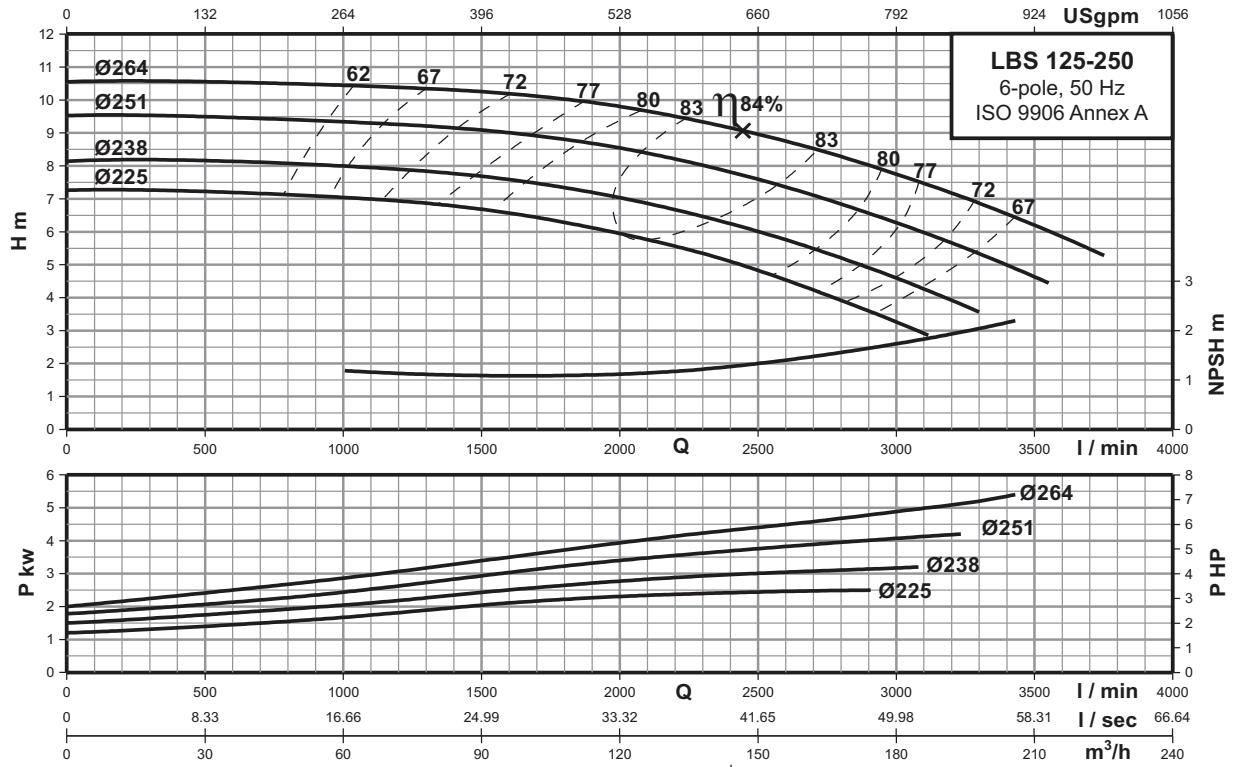

Technical data

Power	[kw]	2.2	3	4	5.5
	[hp]	3	4	5.5	7.5
Frame		112M	132S	132S	132M
PN	[bar]	16	16	16	16
DNs	[mm]	150	150	150	150
DNd	[mm]	125	125	125	125
a	[mm]	140	140	140	140
h2	[mm]	355	355	355	355
L	[mm]	1026	1091	1091	1129
l1	[mm]	1250	1250	1250	1250
l2	[mm]	205	205	205	205
l3	[mm]	840	840	840	840
b1	[mm]	430	430	430	430
b2	[mm]	540	540	540	540
b3	[mm]	490	490	490	490
d	[mm]	24	24	24	24
a2	[mm]	90	90	90	90
h	[mm]	80	80	80	80
h3	[mm]	330	330	330	330
h4	[mm]	494	534	534	534
Base frame no.		6	6	6	6
Net Weight	[kg]	194	221	223	242
Gross Weight	[kg]	290	317	319	338
Volume	[m³]	0.898	0.898	0.898	0.898

6 POLE

Performance curves

LBS 125-315

Single-stage bare shaft end-suction pumps

6-pole

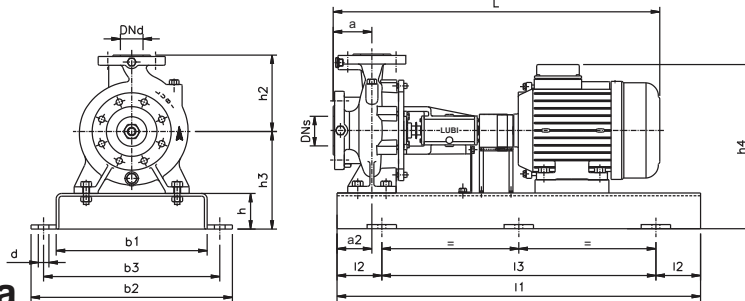
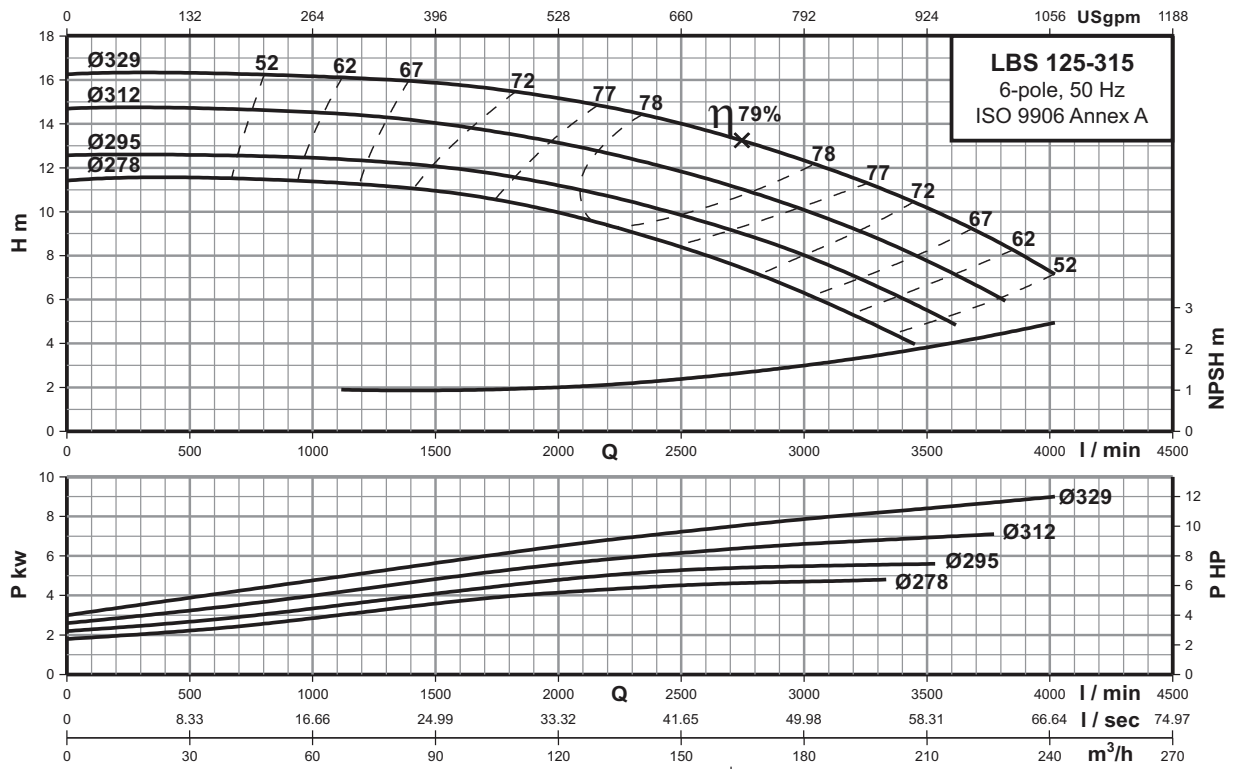

Technical data

Power	[kw]	4	5.5	7.5	9.3
	[hp]	5.5	7.5	10	12.5
Frame		132S	132M	160M	160M
PN	[bar]	16	16	16	16
DNs	[mm]	150	150	150	150
DNd	[mm]	125	125	125	125
a	[mm]	140	140	140	140
h2	[mm]	355	355	355	355
L	[mm]	1151	1189	1289	1289
i1	[mm]	1600	1600	1600	1600
i2	[mm]	270	270	270	270
i3	[mm]	1060	1060	1060	1060
b1	[mm]	530	530	530	530
b2	[mm]	660	660	660	660
b3	[mm]	600	600	600	600
d	[mm]	28	28	28	28
a2	[mm]	110	110	110	110
h	[mm]	100	100	100	100
h3	[mm]	380	380	380	380
h4	[mm]	584	584	623	623
Base frame no.		8	8	8	8
Net Weight	[kg]	285	304	328	334
Gross Weight	[kg]	416	435	459	465
Volume	[m³]	1.452	1.452	1.452	1.452

6 POLE

Performance curves

LBS 125-400

Single-stage bare shaft end-suction pumps

6-pole

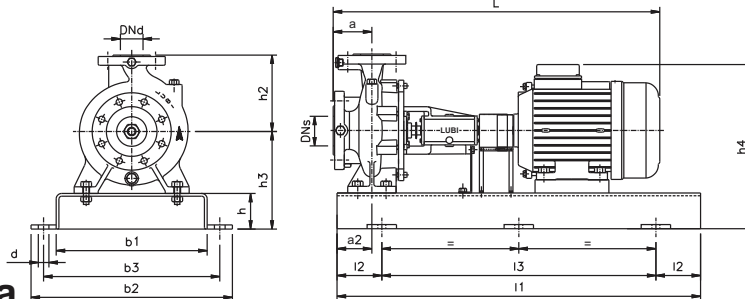
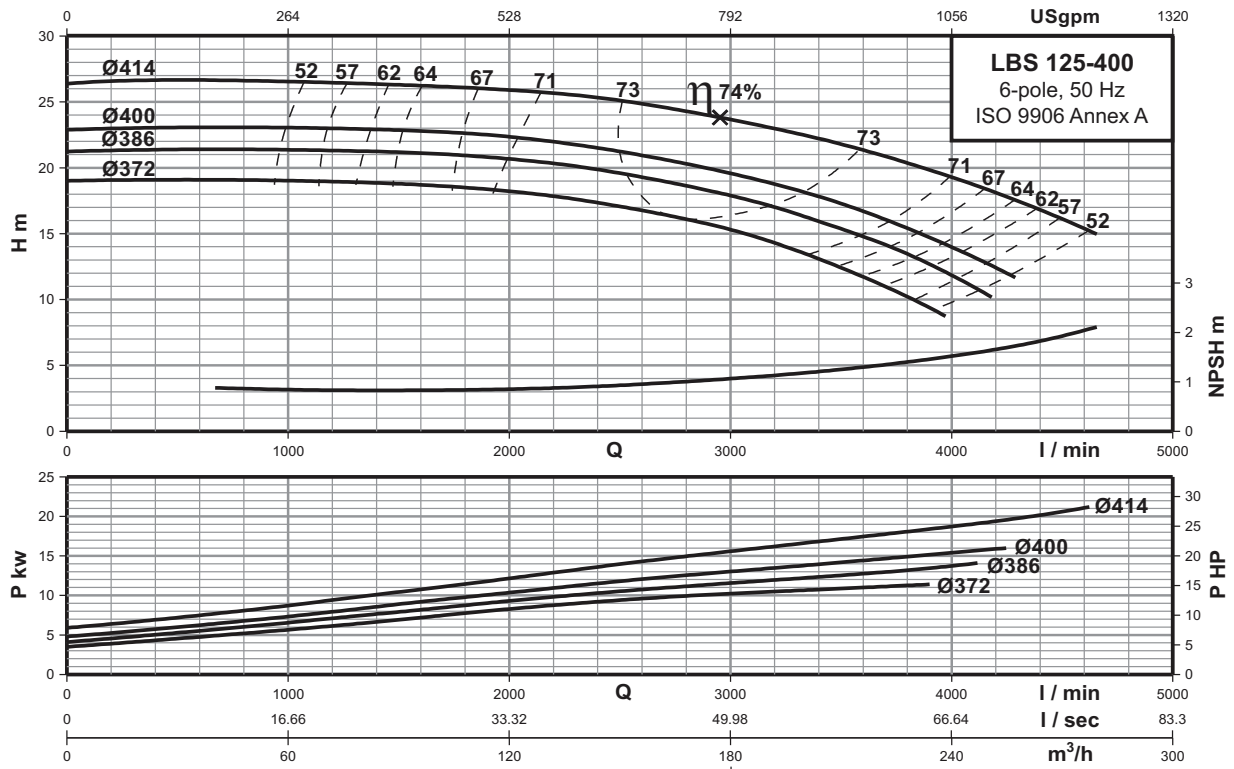

Technical data

Power	[kw]	11	15	18.5	22
	[hp]	15	20	25	30
Frame		160L	180L	200L	200L
PN	[bar]	16	16	16	16
DNs	[mm]	150	150	150	150
DNd	[mm]	125	125	125	125
a	[mm]	140	140	140	140
h2	[mm]	400	400	400	400
L	[mm]	1334	1426	1473	1473
l1	[mm]	1600	1600	1600	1600
l2	[mm]	270	270	270	270
l3	[mm]	1060	1060	1060	1060
b1	[mm]	530	530	530	530
b2	[mm]	660	660	660	660
b3	[mm]	600	600	600	600
d	[mm]	28	28	28	28
a2	[mm]	110	110	110	110
h	[mm]	100	100	100	100
h3	[mm]	415	415	415	415
h4	[mm]	658	709	721	721
Base frame no.		8	8	8	8
Net Weight	[kg]	384	473	521	533
Gross Weight	[kg]	522	611	659	671
Volume	[m³]	1.564	1.564	1.564	1.564

6 POLE

Performance curves

LBS 150-315

Single-stage bare shaft end-suction pumps

6-pole

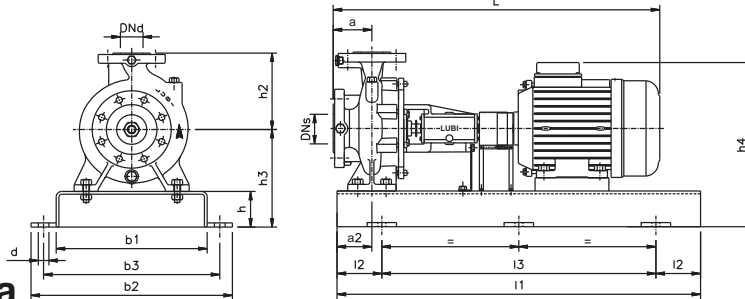
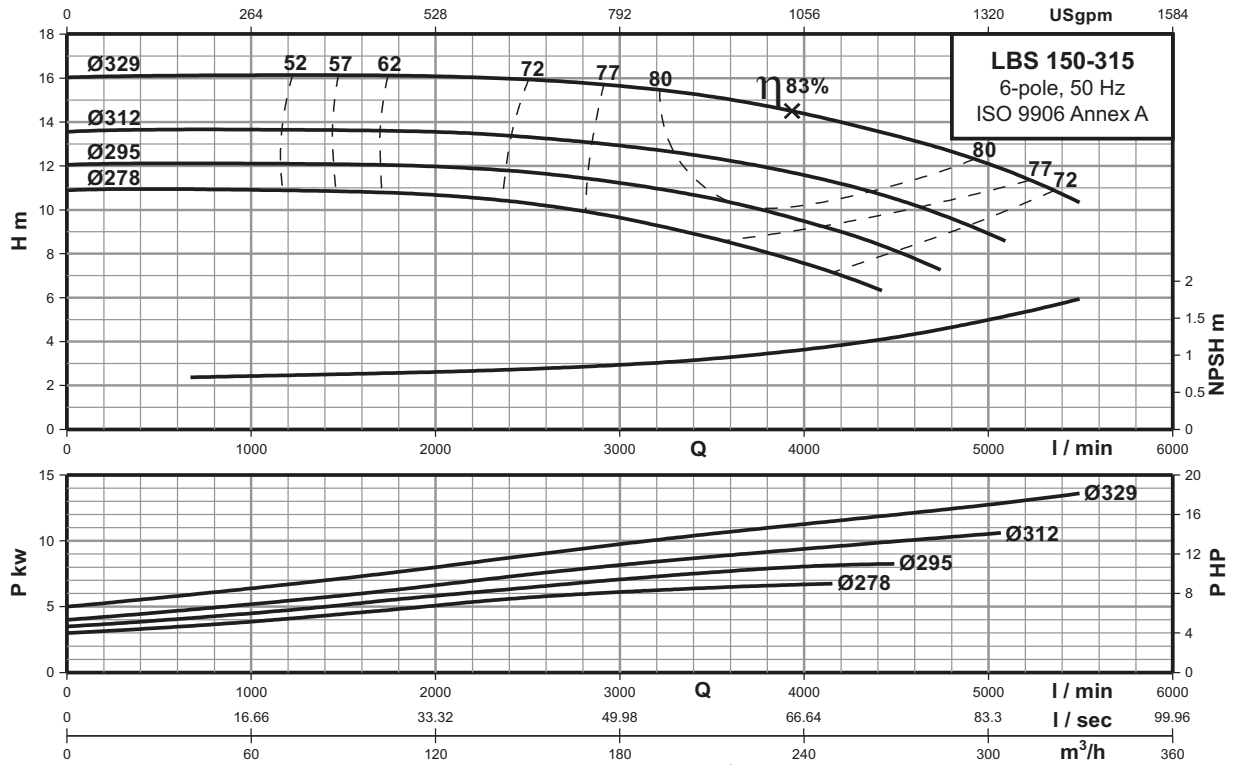

Technical data

Power	[kw]	7.5	9.3	11	15
	[hp]	10	12.5	15	20
Frame		160M	160M	160L	180L
PN	[bar]	16	16	16	16
DNs	[mm]	200	200	200	200
DNd	[mm]	150	150	150	150
a	[mm]	160	160	160	160
h2	[mm]	400	400	400	400
L	[mm]	1309	1309	1354	1446
l1	[mm]	1800	1800	1800	1800
l2	[mm]	300	300	300	300
l3	[mm]	1200	1200	1200	1200
b1	[mm]	600	600	600	600
b2	[mm]	730	730	730	730
b3	[mm]	670	670	670	670
d	[mm]	28	28	28	28
a2	[mm]	110	110	110	110
h	[mm]	100	100	100	100
h3	[mm]	380	380	380	380
h4	[mm]	623	623	623	674
Base frame no.		9	9	9	9
Net Weight	[kg]	370	376	390	479
Gross Weight	[kg]	518	524	538	627
Volume	[m³]	1.720	1.720	1.720	1.720

6 POLE

Performance curves

LBS 150-400

Single-stage bare shaft end-suction pumps

6-pole

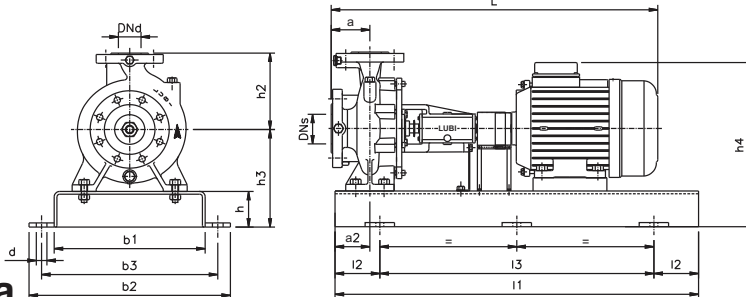
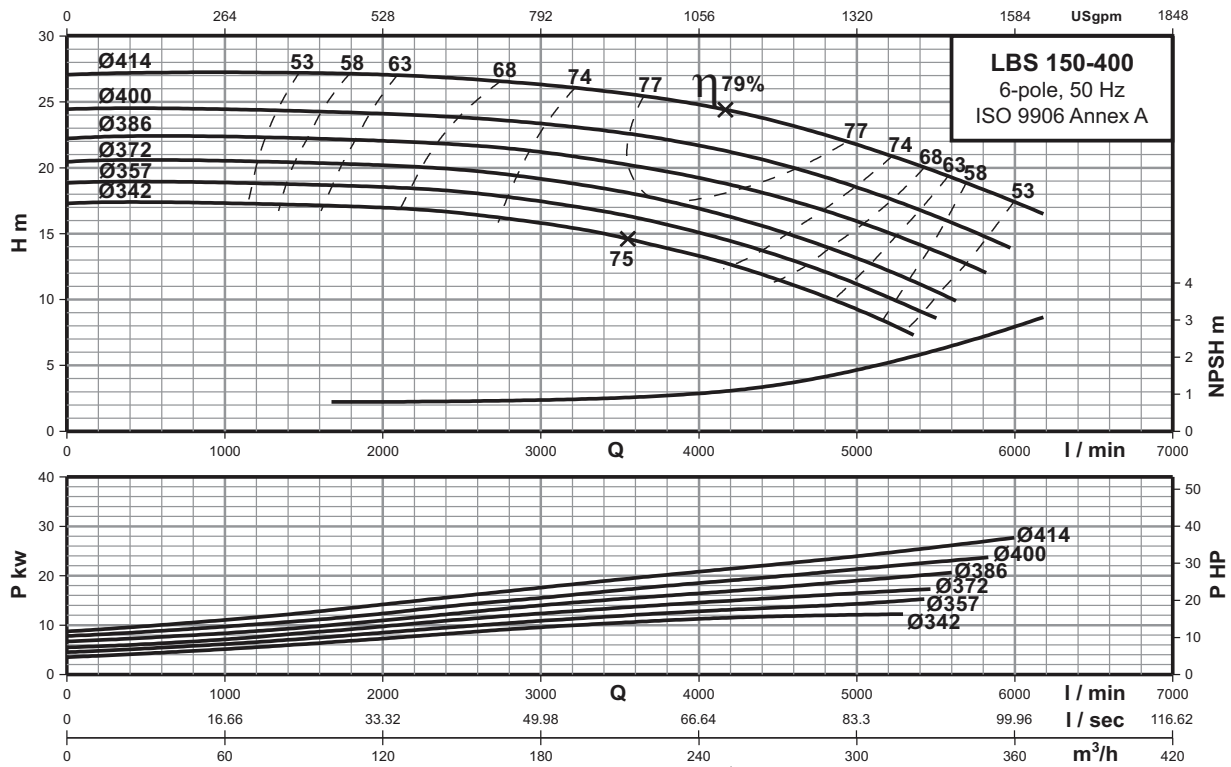

Technical data

Power	[kw]	15	18.5	22	30
	[hp]	20	25	30	40
Frame		180L	200L	200L	225M
PN	[bar]	16	16	16	16
DNs	[mm]	200	200	200	200
DNd	[mm]	150	150	150	150
a	[mm]	160	160	160	160
h2	[mm]	450	450	450	450
L	[mm]	1446	1493	1493	1560
i1	[mm]	1800	1800	1800	1800
i2	[mm]	300	300	300	300
i3	[mm]	1200	1200	1200	1200
b1	[mm]	600	600	600	600
b2	[mm]	730	730	730	730
b3	[mm]	670	670	670	670
d	[mm]	28	28	28	28
a2	[mm]	110	110	110	110
h	[mm]	100	100	100	100
h3	[mm]	415	415	415	415
h4	[mm]	709	721	721	743
Base frame no.		9	9	9	9
Net Weight	[kg]	512	560	572	646
Gross Weight	[kg]	673	721	733	807
Volume	[m³]	1.973	1.973	1.973	1.973

6 POLE

Base frames

Single-stage bare shaft end-suction pumps

LBS

Base frames

The dimensional sketches below show the dimensions of the base frames fitted to LBS pumps.

The type number of the base frame is stated for each LBS pump mentioned in the Technical data.

Base frame type No.	Base frame
2	
3	
4	
5	

Base frames

Single-stage bare shaft end-suction pumps

LBS

Base frame type No.	Base frame
6	
7	
8	
9	
10	

Accessories

Single-stage bare shaft end-suction pumps

LBS

Counter flanges

Cast iron pumps (version-A,B,C,D)

For threaded connection, flanges are made of cast iron.
For welding connection, flanges are made of carbon steel.

CF-8 & Bronze pumps (version-E,F)

For threaded connection, flanges are made of CF-8.
For welding connection, flanges are made of S.S.304.

CF-8M pumps (version-G)

For threaded connection, flanges are made of CF-8M.
For welding connection, flanges are made of S.S.316.

A set of consist on one counter flange, one gasket of rubber material and the requisite number of bolts and nuts.

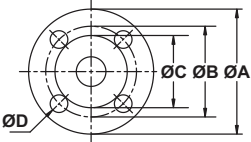
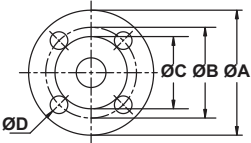
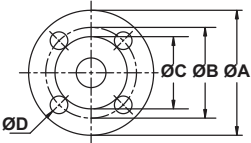
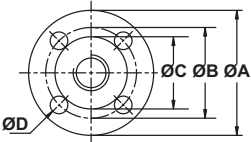
Counter flange	Flange size	Description		A	B	C	ØDxQty. of Holes	Pipework connection	Product number
	DN 32	Threaded	PN 16	Ø140	Ø100	Ø78	Ø18X4	Rp 1¼ BSP**	0321T*
			PN 25	Ø140	Ø100	Ø78	Ø18X4		0322T*
			ANSI 125	Ø115	Ø89	-	Ø5/8"X4	Rp 1¼ NPT	0323T*
			ANSI 250	Ø135	Ø98	Ø78	Ø3/4"X4		0324T*
		For welding	PN 16	Ø140	Ø100	Ø78	Ø18X4	32 mm	0321W*
			PN 25	Ø140	Ø100	Ø78	Ø18X4		0322W*
			ANSI 125	Ø115	Ø89	-	Ø5/8"X4		0323W*
			ANSI 250	Ø135	Ø98	Ø78	Ø3/4"X4		0324W*
	DN 40	Threaded	PN 16	Ø150	Ø110	Ø88	Ø18X4	Rp 1½ BSP**	0401T*
			PN 25	Ø150	Ø110	Ø88	Ø18X4		0402T*
			ANSI 125	Ø125	Ø98	-	Ø5/8"X4	Rp 1½ NPT	0403T*
			ANSI 250	Ø155	Ø114	Ø91	Ø7/8"X4		0404T*
		For welding	PN 16	Ø150	Ø110	Ø88	Ø18X4	40 mm	0401W*
			PN 25	Ø150	Ø110	Ø88	Ø18X4		0402W*
			ANSI 125	Ø125	Ø98	-	Ø5/8"X4		0403W*
			ANSI 250	Ø155	Ø114	Ø91	Ø7/8"X4		0404W*
	DN 50	Threaded	PN 16	Ø165	Ø125	Ø102	Ø18X4	Rp 2 BSP**	0501T*
			PN 25	Ø165	Ø125	Ø102	Ø18X4		0502T*
			ANSI 125	Ø150	Ø121	-	Ø3/4"X4	Rp 2 NPT	0503T*
			ANSI 250	Ø165	Ø127	Ø106	Ø3/4"X8		0504T*
		For welding	PN 16	Ø165	Ø125	Ø102	Ø18X4	50 mm	0501W*
			PN 25	Ø165	Ø125	Ø102	Ø18X4		0502W*
			ANSI 125	Ø150	Ø121	-	Ø3/4"X4		0503W*
			ANSI 250	Ø165	Ø127	Ø106	Ø3/4"X8		0504W*
	DN 65	Threaded	PN 16	Ø185	Ø145	Ø122	Ø18X4	Rp 2½ BSP**	0651T*
			PN 25	Ø185	Ø145	Ø122	Ø18X8		0652T*
			ANSI 125	Ø180	Ø140	-	Ø3/4"X4	Rp 2½ NPT	0653T*
			ANSI 250	Ø190	Ø149	Ø125	Ø7/8"X8		0654T*
		For welding	PN 16	Ø185	Ø145	Ø122	Ø18X4	65 mm	0651W*
			PN 25	Ø185	Ø145	Ø122	Ø18X8		0652W*
			ANSI 125	Ø180	Ø140	-	Ø3/4"X4		0653W*
			ANSI 250	Ø190	Ø149	Ø125	Ø7/8"X8		0654W*

Accessories

Single-stage bare shaft end-suction pumps

LBS

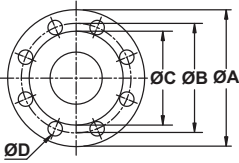
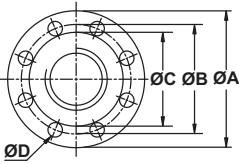
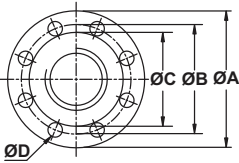
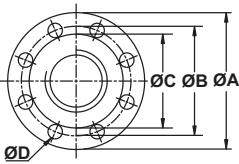
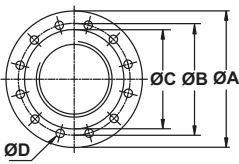
Counter flange	Flange size	Description		A	B	C	ØDxQty. of Holes	Pipework connection	Product number
	DN 80	Threaded	PN 16	Ø200	Ø160	Ø138	Ø18X8	Rp 3 BSP**	0801T*
			PN 25	Ø200	Ø160	Ø138	Ø18X8		0802T*
			ANSI 125	Ø190	Ø152	-	Ø3/4"X4	Rp 3 NPT	0803T*
			ANSI 250	Ø210	Ø168	Ø144	Ø7/8"X8		0804T*
		For welding	PN 16	Ø200	Ø160	Ø138	Ø18X8	80 mm	0801W*
			PN 25	Ø200	Ø160	Ø138	Ø18X8		0802W*
			ANSI 125	Ø190	Ø152	-	Ø3/4"X4		0803W*
			ANSI 250	Ø210	Ø168	Ø144	Ø7/8"X8		0804W*
	DN 100	Threaded	PN 16	Ø235	Ø180	Ø158	Ø18X8	Rp 4 BSP**	1001T*
			PN 25	Ø235	Ø190	Ø158	Ø22X8		1002T*
			ANSI 125	Ø230	Ø191	-	Ø3/4"X8	Rp 4 NPT	1003T*
			ANSI 250	Ø255	Ø200	Ø176	Ø7/8"X8		1004T*
		For welding	PN 16	Ø235	Ø180	Ø158	Ø18X8	100 mm	1001W*
			PN 25	Ø235	Ø190	Ø158	Ø22X8		1002W*
			ANSI 125	Ø230	Ø191	-	Ø3/4"X8		1003W*
			ANSI 250	Ø255	Ø200	Ø176	Ø7/8"X8		1004W*
	DN 125	Threaded	PN 16	Ø270	Ø210	Ø188	Ø18X8	Rp 5 BSP**	1251T*
			PN 25	Ø270	Ø220	Ø188	Ø25X8		1252T*
			ANSI 125	Ø255	Ø216	-	Ø7/8"X8	Rp 5 NPT	1253T*
			ANSI 250	Ø280	Ø235	Ø211	Ø7/8"X8		1254T*
		For welding	PN 16	Ø270	Ø210	Ø188	Ø18X8	125 mm	1251W*
			PN 25	Ø270	Ø220	Ø188	Ø25X8		1252W*
			ANSI 125	Ø255	Ø216	-	Ø7/8"X8		1253W*
			ANSI 250	Ø280	Ø235	Ø211	Ø7/8"X8		1254W*
	DN 150	Threaded	PN 16	Ø300	Ø240	Ø212	Ø22X8	Rp 6 BSP**	1501T*
			PN 25	Ø300	Ø250	Ø212	Ø25X8		1502T*
			ANSI 125	Ø280	Ø241	-	Ø7/8"X8	Rp 6 NPT	1503T*
			ANSI 250	Ø320	Ø270	Ø246	Ø7/8"X12		1504T*
		For welding	PN 16	Ø300	Ø240	Ø212	Ø22X8	150 mm	1501W*
			PN 25	Ø300	Ø250	Ø212	Ø25X8		1502W*
			ANSI 125	Ø280	Ø241	-	Ø7/8"X8		1503W*
			ANSI 250	Ø320	Ø270	Ø246	Ø7/8"X12		1504W*
	DN 200	Threaded	PN 16	Ø360	Ø295	Ø268	Ø22X12	Rp 8 BSP**	2001T*
			PN 25	Ø360	Ø310	Ø268	Ø25X12		2002T*
			ANSI 125	Ø345	Ø299	-	Ø7/8"X8	Rp 8 NPT	2003T*
			ANSI 250	Ø380	Ø330	Ø303	Ø1-1/8"X12		2004T*
		For welding	PN 16	Ø360	Ø295	Ø268	Ø22X12	200 mm	2001W*
			PN 25	Ø360	Ø310	Ø268	Ø25X12		2002W*
			ANSI 125	Ø345	Ø299	-	Ø7/8"X8		2003W*
			ANSI 250	Ø380	Ø330	Ø303	Ø1-1/8"X12		2004W*

* Add a subscript as per following example to part number.

0321TCI for cast iron flanges.

0321TS1 for S.S 304 flanges.

0321TS2 for S.S 316 flanges.

0321WCS for carbon steel flanges.

** NPT threaded flanges are also available on request.